



NINZ S.p.A. - corso Trento, 2/A
I-38061 ALA (TN) / ITALY www.ninz.it
Tel. + 39 0 464 678300
Fax. +39 0 464 679025 info@ninz.it

KIT SLASH INOX A

PANIC EXIT DEVICE for emergency exits

A132-GB

5001211/1 - 01/24

Commercial codes

4204302.027 KIT SLASH INOX A for REVER
and UNIVER doors - multipurpose
4204302.030 KIT SLASH INOX AR for REVER
and UNIVER doors - multipurpose

Name and address of the producer NINZ S.p.A. - corso Trento 2/A
I-38061 ALA (TN) - ITALY

Year application trademark 2007

Standard EN 1125:2008 + EC1:2009

Certification authority nr. 0425

CE certification number 0425-CPR-001308

DoP no. **1125-SL-01**

Website <https://www.ninz.it/it/download/dop>

Classification 3 7 7 B 1 3 2 2 B A



Classification nr.

- 1st Character - grade 3 - Category of use: high frequency
- 2nd Character - grade 7 - Durability: 200.000 cycles
- 3rd Character - grade 7 - Mass of the door: over 200kg
- 4th Character - grade B - Suitable for use on fire/smoke rated doors
- 5th Character - grade 1 - Safety: suitable for emergency exits
- 6th Character - grade 3 - Highly resistant to corrosion 96h
- 7th Character - grade 2 - Safety of goods: 1000N
- 8th Character - grade 2 - Protrusion of the device: up to 100mm
- 9th Character - grade B - Activation type: touch bar
- 10th Character - grade A - Suitable for 1 or 2 leaved door

Suitable for doors with one leaf or for the active leaf (primary) of two-leaved doors up to 1350x2880mm/leaf in size, a mass of up to 300kg/leaf, mounted on hinges or pivots, fire resistant up to EI²120 – REI120 and smoke proof. Protrusion of the exit bar: 75mm.



SYMBOLS EMPLOYED

-  **CAUTION**
Indicates a danger that threatens people and/or material goods. Failure to observe the warnings indicated by this symbol may have serious consequences, such as personal injury and property damage.
-  **ATTENTION**
Indicates a danger that threatens material goods. Failure to observe the warnings indicated by this symbol may result in damage to material goods.
-  **NOTICE**
Warnings related to important technical aspects.

PRODUCT DESCRIPTION

Panic bar for one-leaved doors or for the active leaf of two-leaved doors located at emergency exits and activated by touch-bar. Composed of galvanized steel controls, black plastic carter, horizontal aluminium bar, external lever handle, panic lock and nickel-plated brass cylinder with three keys.
This product does not contain or release any hazardous materials, as per UNI EN standard nr. 1125 appendix ZA.

OPERATION MODE

While locked by key, the door cannot be opened from the pull side (handle side), while it can always be opened from the push side by using the horizontal bar of the SLASH BM panic exit device.

WARNINGS

The SLASH panic bar activated by means of a horizontal bar is intended for use onto doors installed in escape routes where panic situations could develop. The safety features of this product are of fundamental importance to ensure its conformity with EN 1125. It is strictly forbidden to introduce any type of modifications apart from those described in these installation instructions.

RECOMMENDATIONS

In order to ensure that the panic bar could provide a high level of safety toward people and appropriate safety level toward goods, it should only be mounted onto doors and doorframes that are in good conditions. The door itself, therefore, should be checked to ensure that it was installed properly and that nothing obstructs its normal movement.

If door rebate sealing have been mounted on the door, make sure they do not inhibit proper functioning of the panic bar.

 In case of two-leaved door where both leaves are equipped with panic bar, it is mandatory to check that each leaf opens when its respective panic bar is activated, and that leaves open freely when the bars are activated simultaneously.

The fastening instructions in the present document should be followed scrupulously during installation. Once installation is complete, the installer should give this document to the owner of the activity.

The horizontal bar should be installed in a way that maximizes its useable length.

For securing the door in the closed position, do not employ any other latching devices than those specified in the present document. This does not preclude the installation of automatic closing devices.

Different external access devices than those found on the list of certified components on pages 4/4 are considered unacceptable.

The SLASH panic bar is also designed for installation on hollow metal doors with an internal cell structure.

If a door closer is needed to return the door to the closed position, care should be taken not to make the opening step more difficult for children, the elderly and the disabled.

A pictogram (arrow) should be positioned immediately above the horizontal bar on the internal side of the door.

 All of the included components described herein must be positioned and mounted in conformity with the present document.

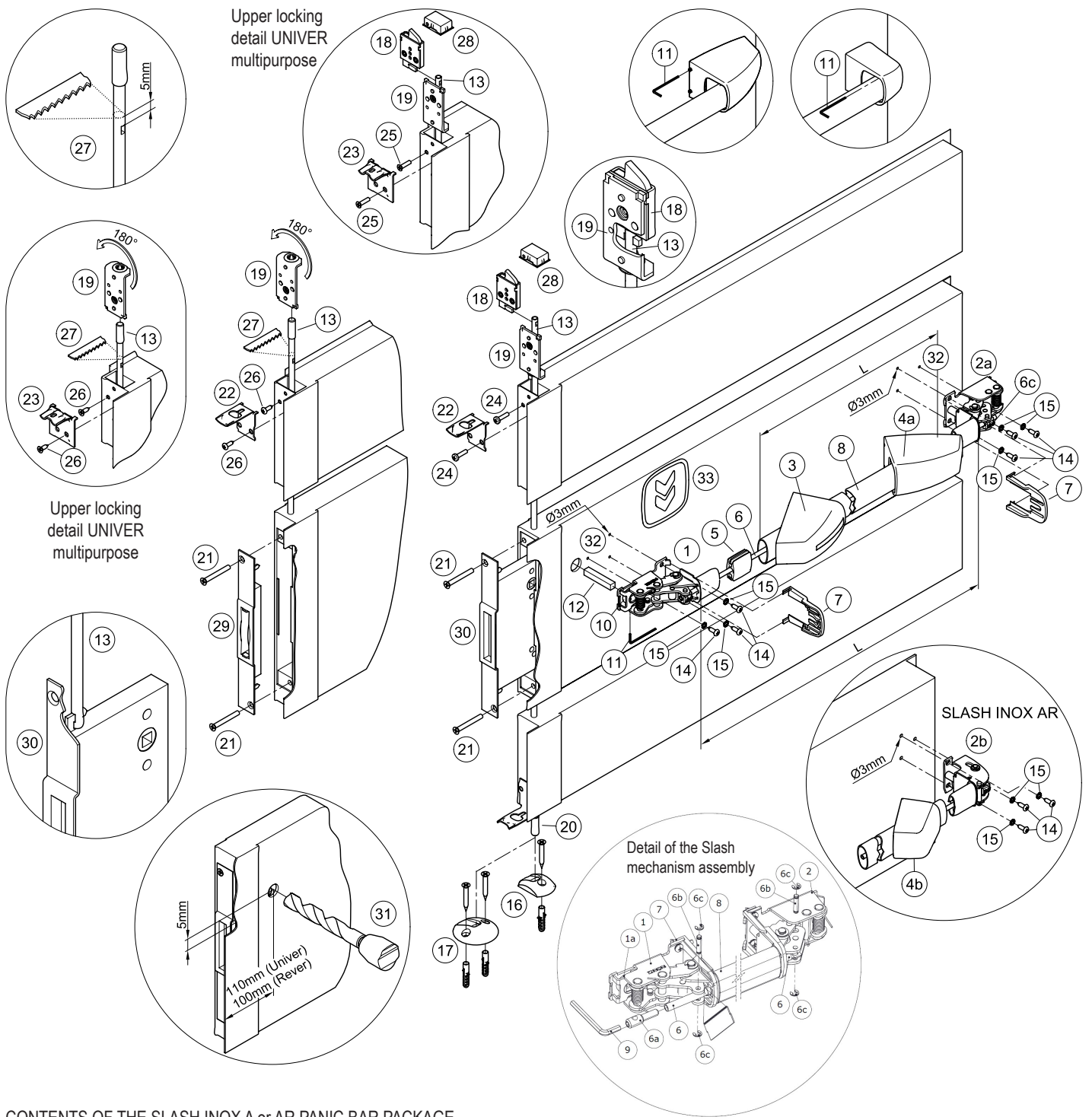

CONTENTS OF THE SLASH INOX A or AR PANIC BAR PACKAGE

position	pcs.	description
1, 2a o 2b	01	Slash or Slash AR mechanism assembly
3, 4a o 4b	01	Slash INOX or Slash INOX AR carter set
5	01	Guide for connection pipe
6	01	Connection pipe
7	02	Protection
8	01	Horizontal bar in stainless steel
9	01	S3 hex key
11	01	S2 hex key
12	01	Square spindle 9x9x52mm
14	06	Pan head self tapping screw Ø4,8x16mm
15	06	Toothed washer
16	01	Rever floor catch with 1 plastic anchor
17	01	Univer floor catch with 2 plastic anchors

position	pcs.	description
18	01	Upper bolt-device with screw
24	02	M5x20mm galvanized Philips-head pan head screw (for REVER door)
25	02	M5x20mm black galvanized Philips-head countersunk screw (for UNIVER door)
30	01	Panic safe lock for passive leaf
33	01	Adhesive pictogram (green arrow)
-	01	A034 hole-drilling template
-	01	Slash INOX A or AR Rever or multipurpose Univer panic bar installation instructions

N.B. before mounting the panic exit device the leaf has to be prepared following the installation instructions.

Please note that article 4 of the MD of 03 November 2004 obliges the installer to write up, sign and provide the owner of the activity with a declaration of proper installation that makes explicit reference to the instructions supplied by the exit device manufacturer.

TOOLS REQUIRED
 Medium-sized Philips-head screwdriver or electric screwdriver, medium-sized screwdriver, electric drill and Ø3 and Ø20 mm drill bit for steel, hack-saw for aluminium.

IMPORTANT

- Installation should be carried out by qualified personnel only and in strict conformity with the instructions supplied.
- For a correct installation all supplied components must be used, including toothed washers.
-  - No variations are allowed, and only components indicated in the package contents may be used.
- Given its purpose, the Slash INOX A panic bar should be mounted on the push-side of the inactive leaf and the active leaf has to be fitted with a Slash INOX panic exit device, too.
- Before proceeding with installation, check the package contents to ensure that no pieces are missing.
- Any different installation configuration from that illustrated on pag. 2/4 is not allowed.
- If the door is not yet installed and to avoid any other adaptation operations, it is recommended to define the opening direction at every beginning so that changing operations of the opening direction listed in the installation instructions of the door itself can be executed at the same time. As standard the door is prepared for right hand opening to pull.

INSTALLATION

- To make the work easier, it is best (though not required) to lay the passive (secondary) leaf horizontally across two work benches.
- First disassemble any handles or bar components that are already present.
- Remove the existing panic safe lock (29) by unscrewing the two frontal screws (21).
- The upper vertical rod (13) must be unthread from the central joint dragging with it also the corner steel of the rod (19) by unscrewing the two frontal screws (26) and removing, if present, also the frame-assembling bracket (22 or 23).
- Remove the upper and lower rod-guiding bushings in plastic from the inside of the lock housing by using a flat-blade screwdriver.
- Cut the spindle of the upper vertical rod (13) at 5mm from the buttonhole (27).
- Place the upper bolt-device (18) included in the KIT, join rod (13), corner steel of the rod (19) turned for 180° and bracket (22 or 23) in the right position and rescrew all with the two M5x20 mm screws (24 or 25). The lower vertical rod (20) remains unchanged.

-  - Install the new panic safe lock (30), making sure to center the square hole of both rods. The operation should be carried out with great care, making sure not to ruin or displace any of the components inside the lock housing. Attention: the hole for the square spindle on the lock mechanism should be turned towards the upper part of the door. Reuse the two M6x50mm screws (21) for the fastening of the panic safe lock. Ensure that the two rods are attached and can move freely.

- If not already installed, apply the floor catch (16 or 17) by attaching it with the appropriate screws and fasteners according to the door installation instructions.
- Continue with installing the panic exit device and if no hole should have been provided for the passage of the square spindle (12), drill the hole in the metal panel at the push-side of the door at the position indicated in figure (31) by using the Ø20mm drill bit.
- Use the template to drill the holes (32) with the Ø3mm drill bit, checking the level. If holes are already present, drill them again for the internal reinforcement.

-  - Insert the square spindle (12) into the cam (10) of the operating mechanism (1) so that it protrudes 38mm, fix it in this position with the S2 hex key (11).

- Approach the operating mechanism (1) of the panic device at the lock-side (push side of the door), with the lift of the cam (10) turned downwards. Centre correctly the square hole of the panic safe lock (30), fasten the mechanism with the Ø4,8x16mm self-tapping screws (14) and their toothed washers (15).
- Fasten the mechanism (2a or 2b) of the panic bar at hinged side, using the self-tapping screws Ø4,8x16mm (14) and their toothed washers (15).
- Make a precise "L" measurement, cut the horizontal stainless steel bar (8), and remove the burrs from the cut edge. Insert the guide (5) for the connection pipe in the center of the bar (8).
- Take out the mechanism (2a or 2b) in order to insert the horizontal bar (8) in the operating mechanism (1); then insert also the connection pipe (6).
- Insert the plastic in the horizontal bar, first the one with the sticker (3), then the other one without (4a or 4b). Join the bar with the hinged side mechanism (2a or 2b) inserting also the connection pipe (6) before refastening the mechanism at the door. The flattened side of the pipe (6) has to be inserted from hinge side.
- Fasten the connection pipe (6) from the hinge side inserting the blocking pin (6b) in the provided hole in the connection pipe (6) and fastening with the 2 seeger rings (6c).

- Maintaining pulled the horizontal bar (8) cut the connection pipe (6) leaving it protruding for about 5mm from the operating bar (8). Insert then the pin (6A) in the connection pipe by means of the hexagonal key S3 (9). The pin has to be fastened until the holes for the blocking pin (6b) are centered. Insert then the blocking pin (6b) in the hole of the connection pin (6a) and fastening it with the 2 seeger rings (6c).
- Insert the protections (7) in the designated guides of both mechanisms (for AR only at the lock-side).
- Apply the carters (3 and 4a or 4b) on the relative mechanisms while ensuring that the protections (7) remain in their position. Clip on the carters by pushing softly the horizontal bar; first the narrow side, then the wide side. Finally fix the carters fastening their socket set screw without forcing, using the S2 hex key (11).

-  - Push the Slash INOX A panic bar at any point along the horizontal bar to check the complete exit of the counter-latchbolt and the full retraction of the upper bolt-device (18) as well as the lower rod (20). Test the door in both open and closed positions. In case of fire-rated doors verify that the self-closing sequence of the two leaves operates properly.

- Apply the pictogram (33) with the green arrow on the internal surface of the door, just above the horizontal bar.

-  - Lastly, use a dynamometer to measure the force required on the horizontal bar of the Slash INOX A panic exit device to free the passive leaf from the latch bolt of the lock, from the upper bolt-device and from the lower rod. Record this force measurement in the present document.

USE

- Ensure that the leaf always opens easily.
- Avoid unnecessary strains on or handling of the exit bar.
- Protect the panic bar from external atmospheric agents.
- Avoid anything that could hamper the free movement of the bar.
- Do not paint the panic safe lock of the passive leaf, neither the upper bolt-device, neither the tip of the lower rod and its respective guide.
- Use the bar properly, do not pull it in the wrong direction.
-  - Make sure that any damaged or malfunctioning parts are replaced immediately.

MAINTENANCE

To ensure that door usage conforms with regulations, the following maintenance checks should be carried out at least once a month:

- Confirm that all of the installed components correspond with those listed in the present instructions and that no other latching devices than those originally installed have been added to the door.
- Inspect and activate the panic bar to verify that all of its components are in satisfactory operational condition.
- Use a dynamometer to confirm that the release force shows no significant differences from the forces recorded at the time of installation.

-  - Check whether all screws are fully tightened, tightening any that may have loosened.

- Push the panic bar at any point along the horizontal bar to check the complete exit of the counter-latchbolt and the full retraction of the upper bolt-device (18) as well as the lower rod (20). Test the door in both open and closed positions.
- Once released the horizontal bar and closed the leaf, verify that the counter-latchbolt retracts fully as well as the upper bolt-device and lower rod exit completely.
- Check the horizontal bar and replace it if any damage or deformities are detected.

-  - Ensure that the upper strike box with roller and floor catch are not blocked; if so, remove the obstruction.

- The product requires no special maintenance. Grease spray should be used to lubricate the upper bolt-device, the lower rod guide, internal workings of the lock and panic bar on a regular basis – the latter has a hole on its carter for this purpose.
- For normal cleaning, use a cleaning agent designed specifically for stainless steel.

-  - Any adjustments that become necessary must be carried out by qualified personnel using original NINZ replacement parts.

-  - The owner of the activity is responsible for keeping the declaration of correct installation on file, conducting proper exit bar maintenance in accordance with all of the manufacturer's maintenance guidelines, keeping maintenance and check-up records and preserving the present document.

